



*Fermilab*

---

# *Vector Signal Analyzer*

## *VSA*

*Ralph J. Pasquinelli*



# Fermilab VSA

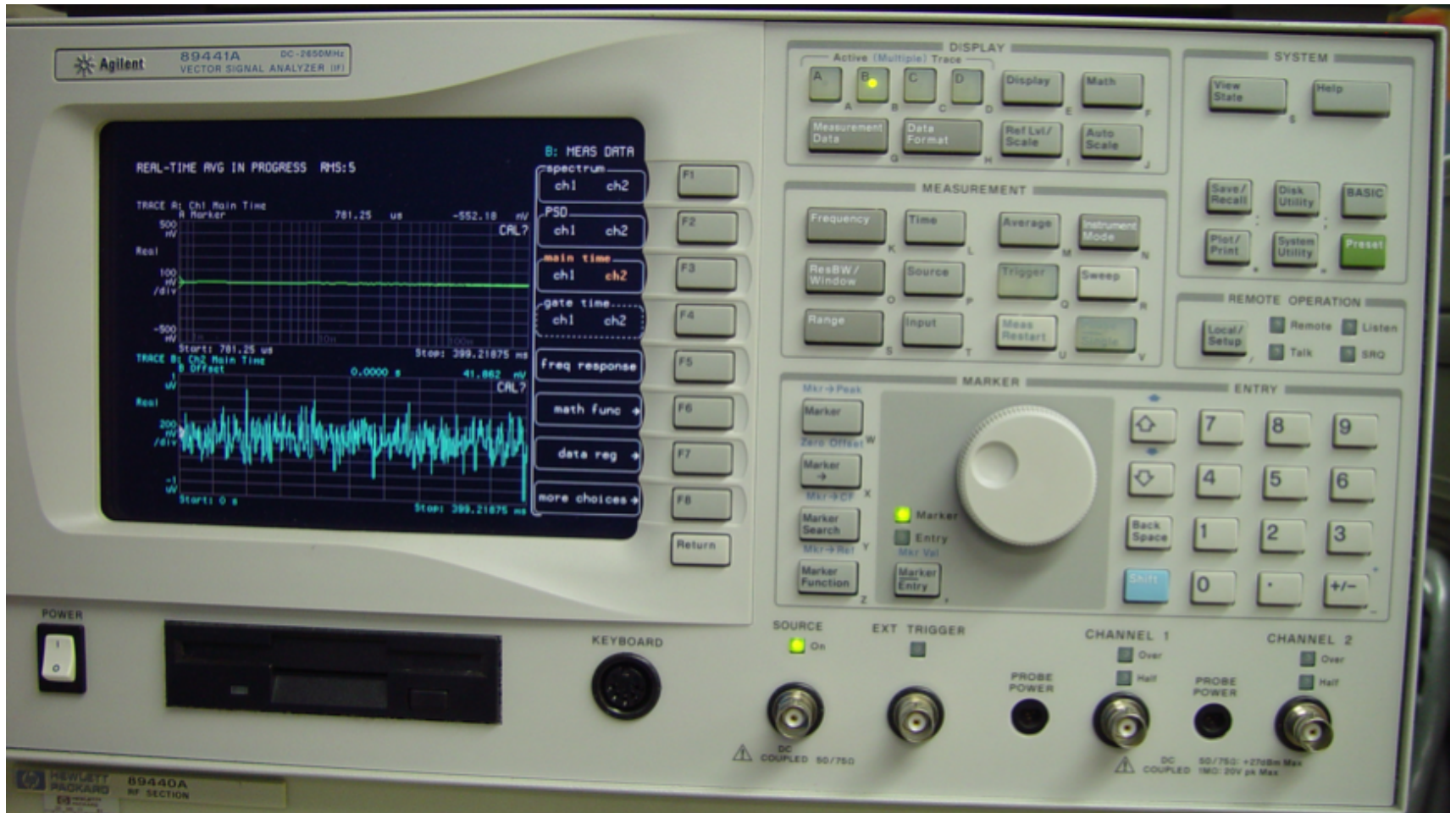



# Agilent 89600 Series Vector Signal Analysis Software

89601A/89601AN/89601N12

## Technical Overview

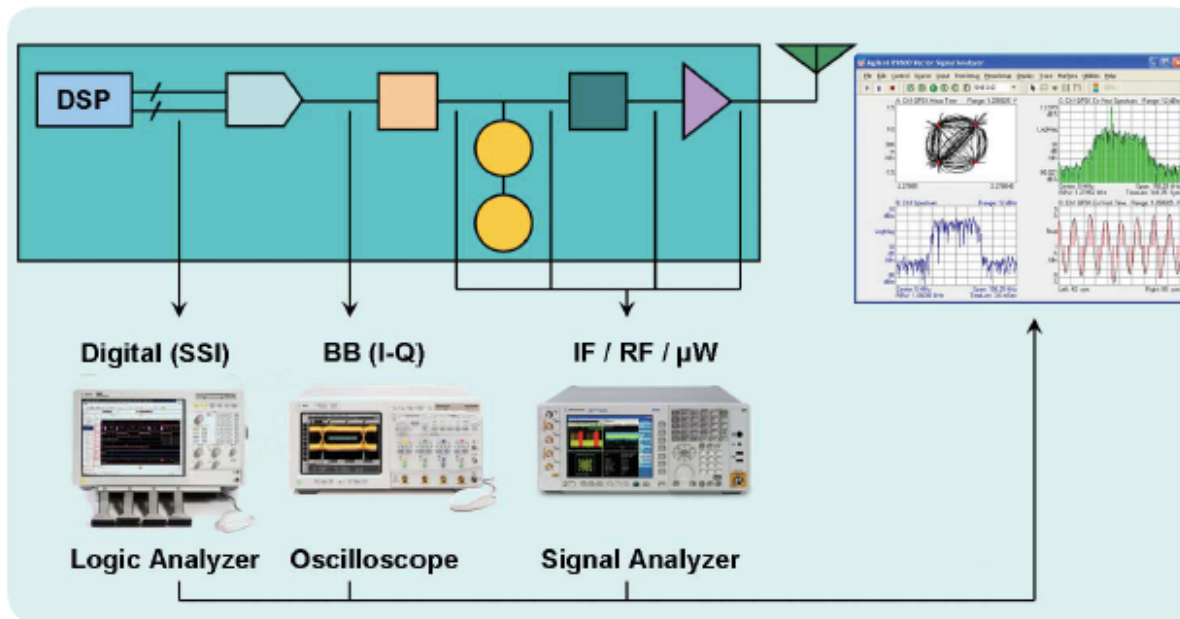



# Fermilab VSA

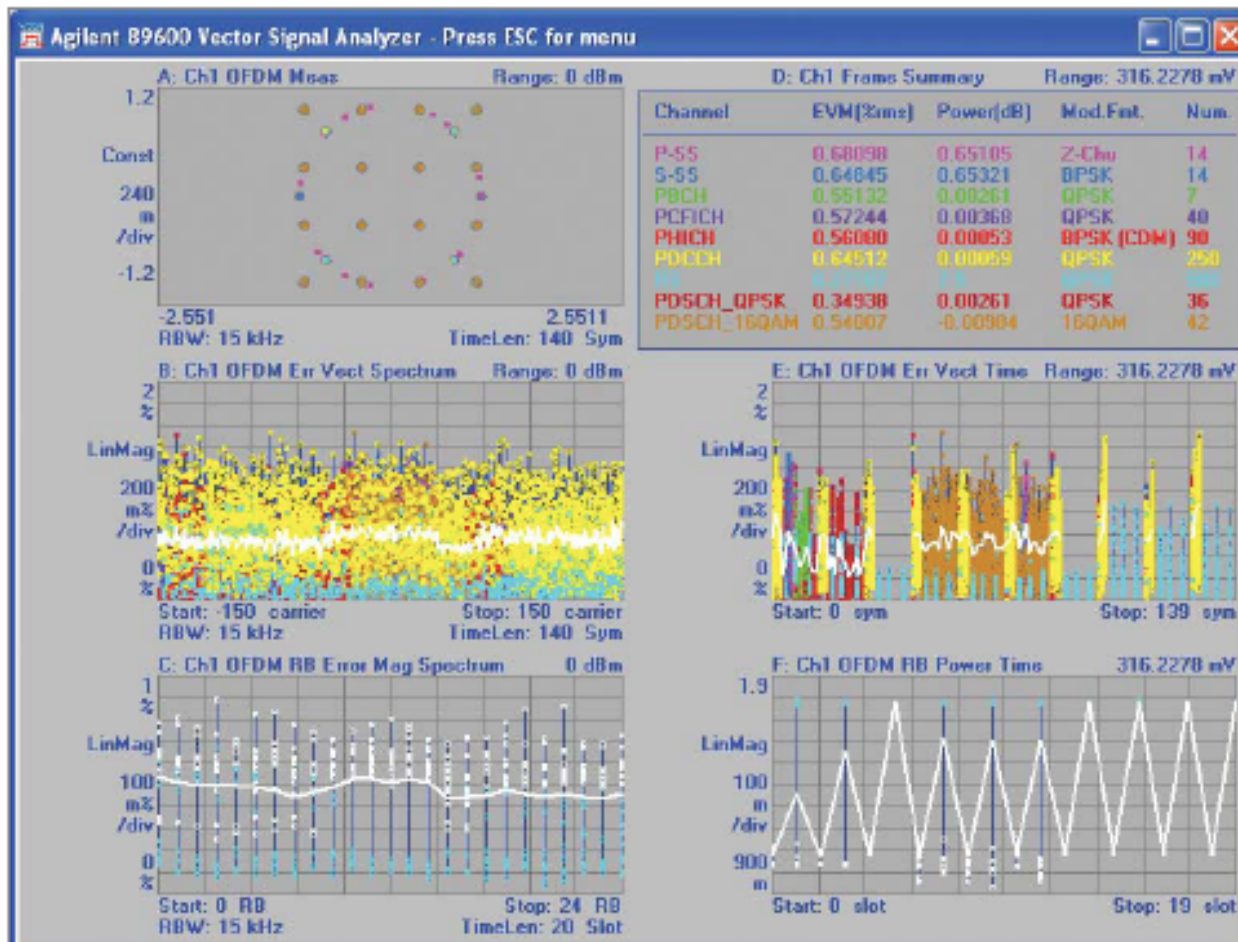



Fourier Transform

$$V(f) = \int_{-\infty}^{\infty} v(t) e^{-j2\pi ft} dt$$

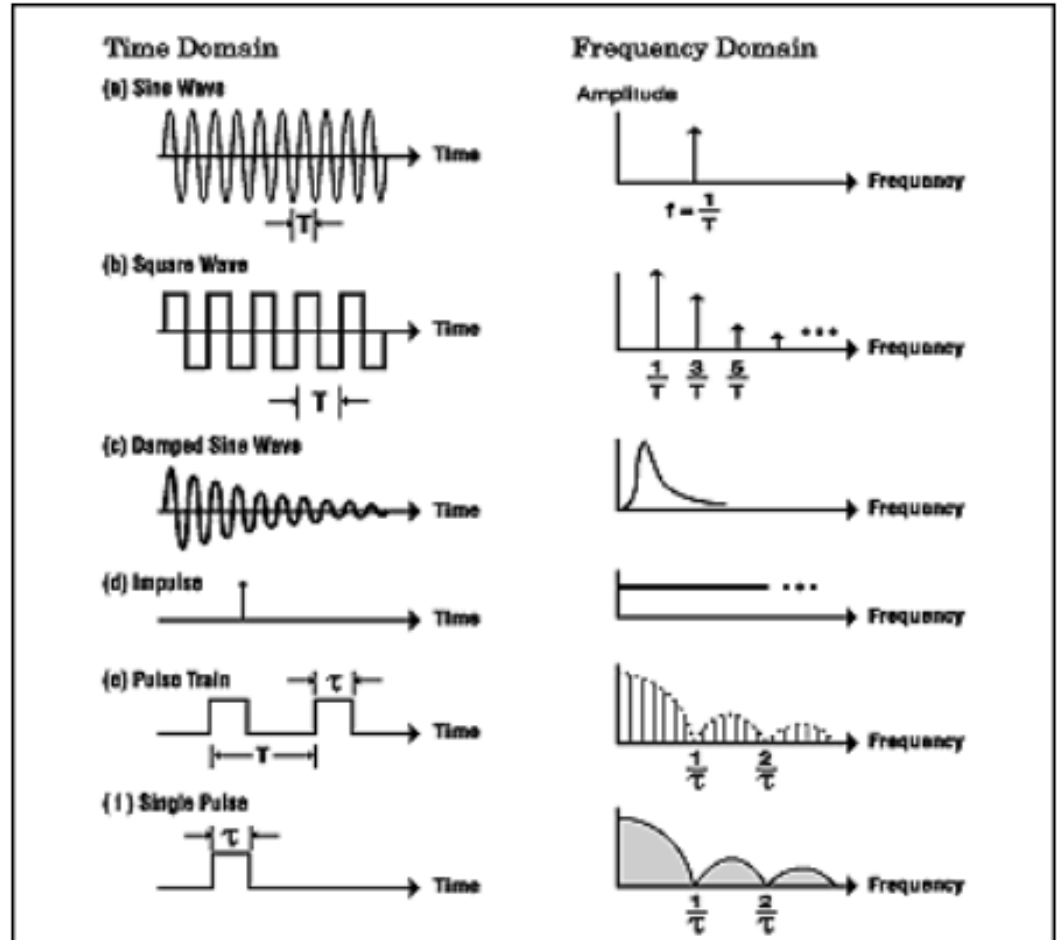



# Discrete Fourier Transform DFT

$$X(k) = \begin{cases} \sum_{n=0}^{N-1} x(n)W_N^{kn}, & 0 \leq k \leq N - 1 \\ 0, & \text{otherwise} \end{cases}$$

where  $W_N = e^{-j(2\pi/N)}$

The Discrete Fourier Transform

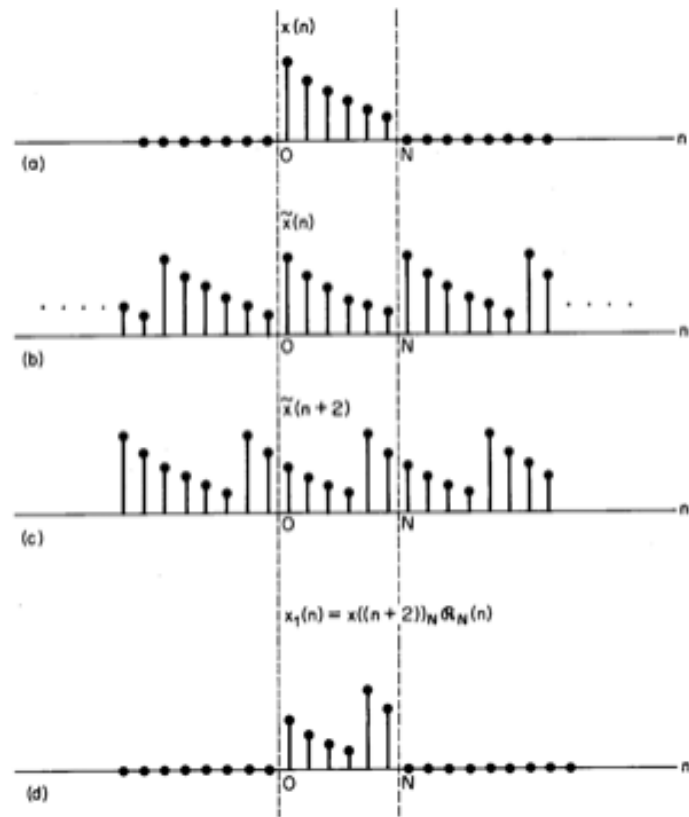



### Fast Fourier Transform FFT

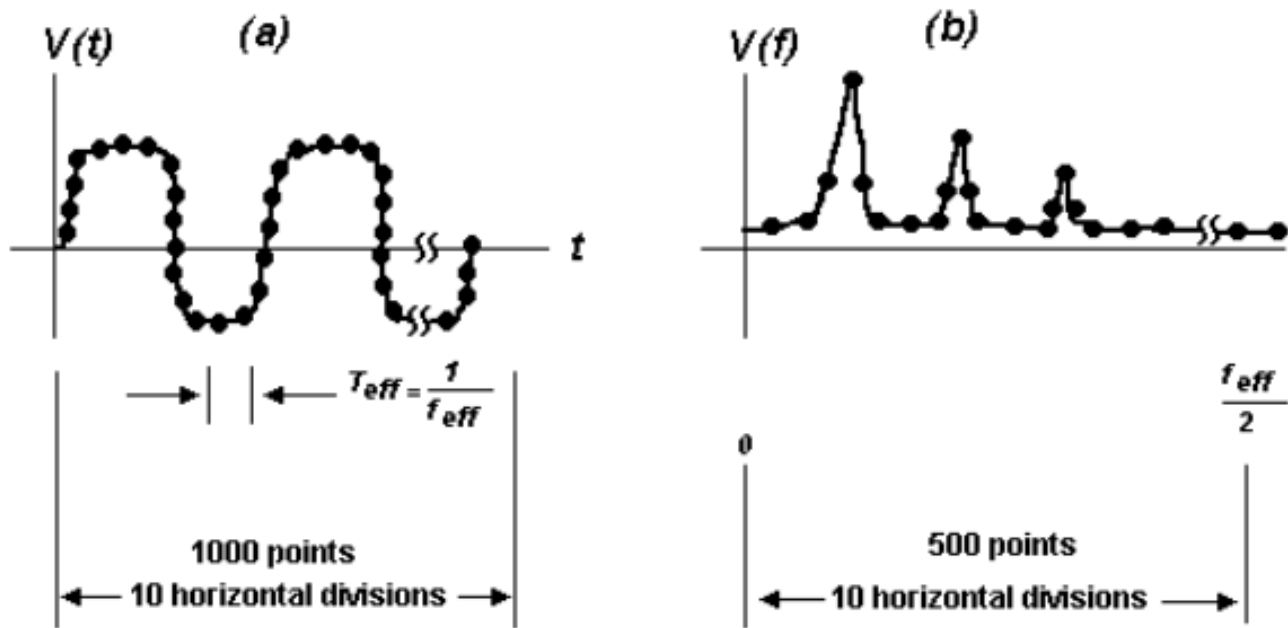

3a).

Figure 3

- (a) The sampled time domain waveform.
- (b) The resulting frequency domain plot using the FFT.



## Aliasing

All Frequencies above  $f_{\text{eff}}/2$  will fold down into the FFT  
And are referred to as aliasing. Input signal must always be  
Sampled at least twice the highest frequency component  
i.e. the Nyquist criteria. A low pass filter before the digitizer  
Called an anti-aliasing filter will limit the frequency response.

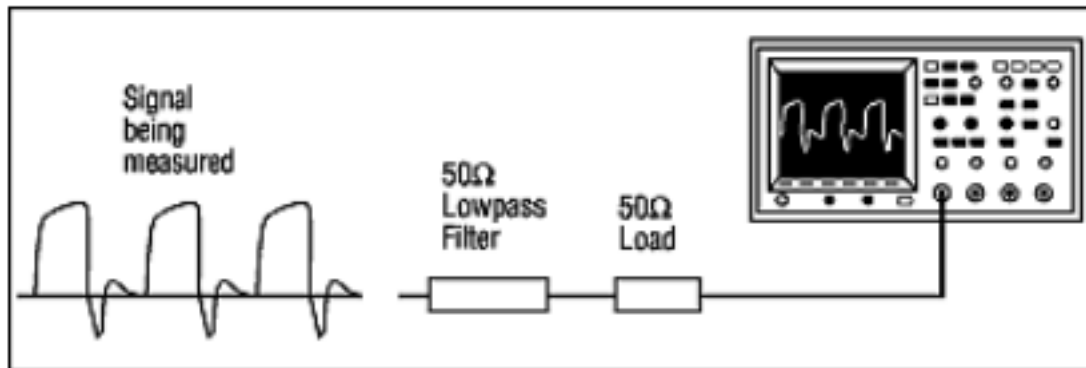

A lowpass filter can be used to band limit the signal, avoiding aliasing.





# Fermilab VSA

*No transients in record*

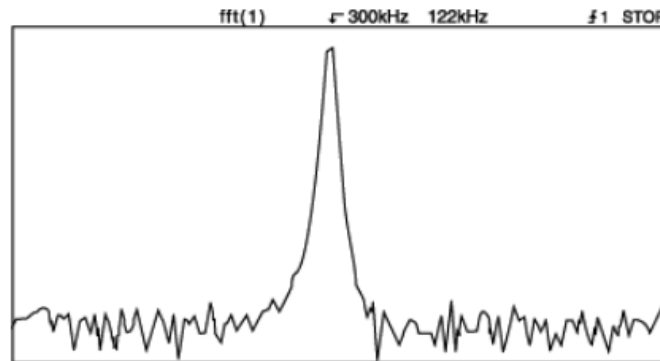
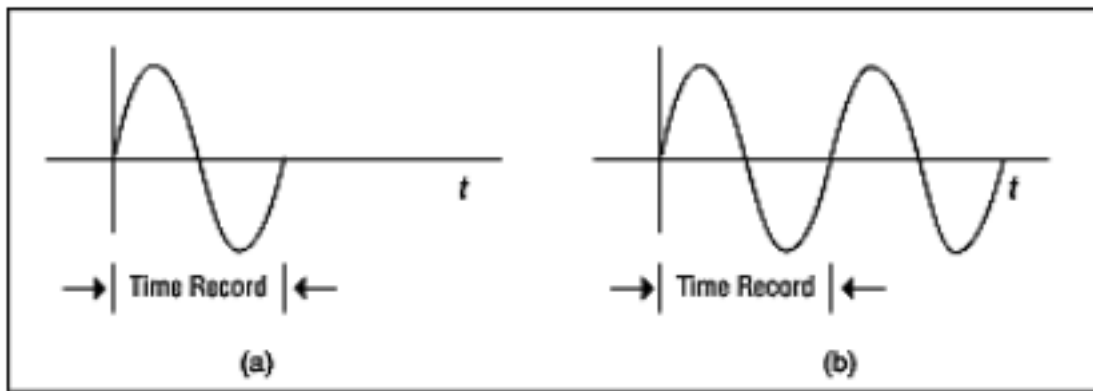



# Fermilab VSA

*Transient in record creates “leakage”*

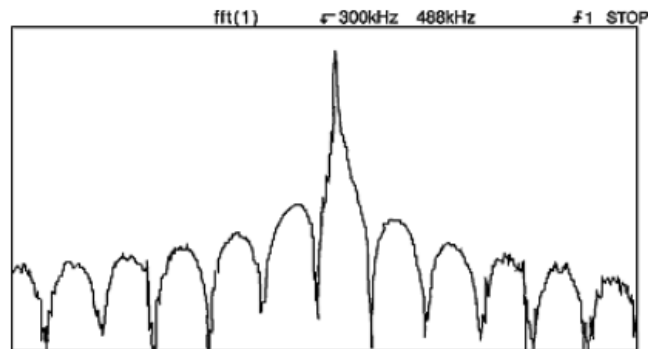
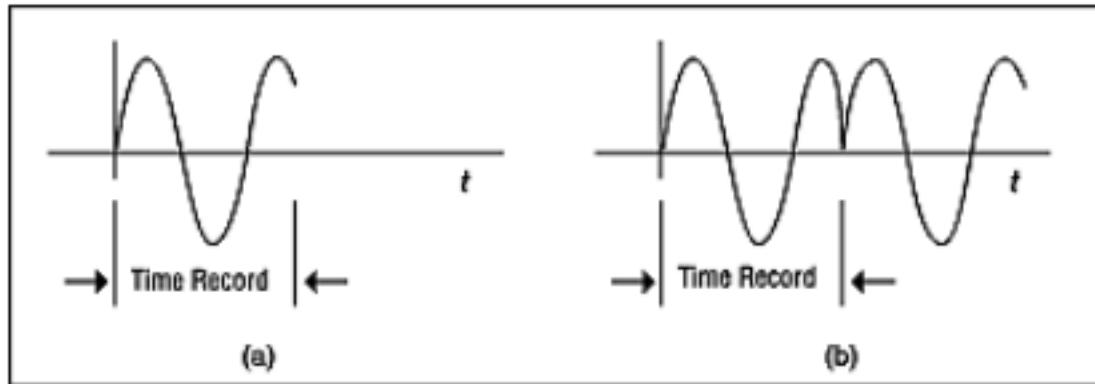



## Windowing

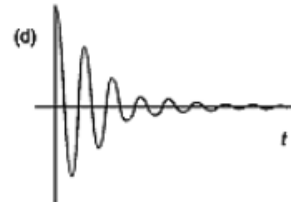
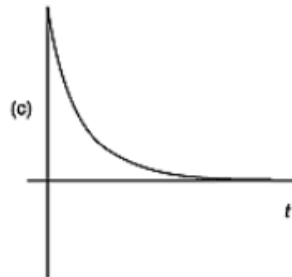
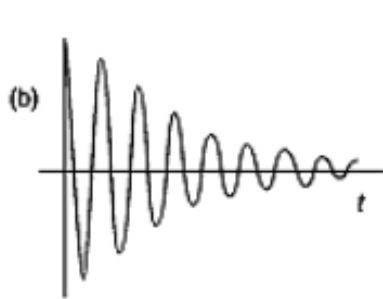
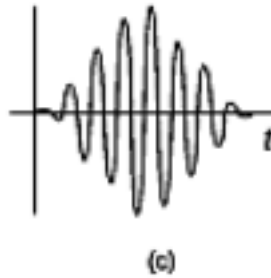
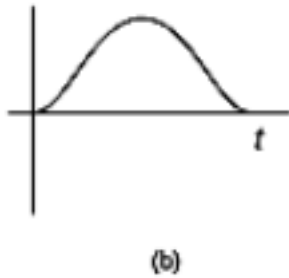
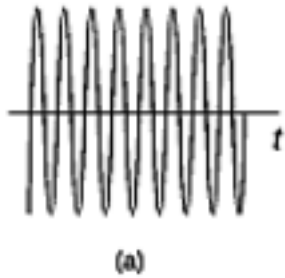

*Hanning Window*  
*Good frequency*  
*Resolution poorer*  
*Amplitude resolution*

*Exponential Window*  
*For transients*



More Windows

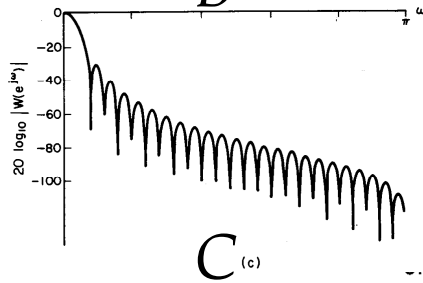
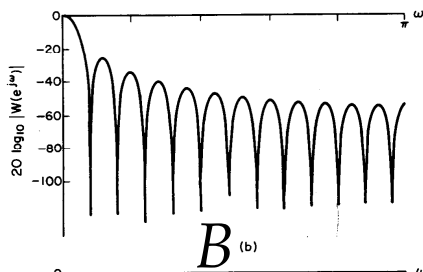
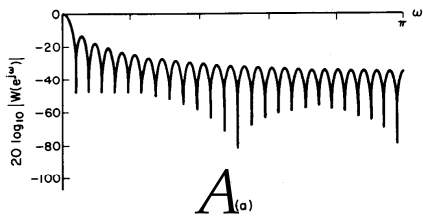

- A Rectangular
- B Triangular
- C Hanning
- D Hamming
- E Blackman

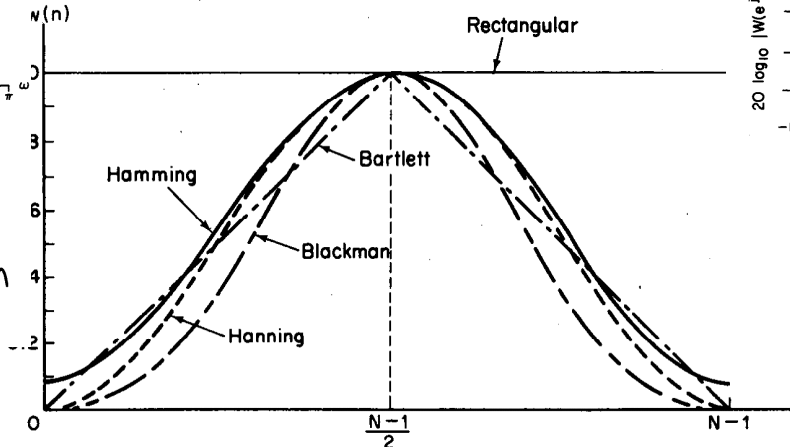
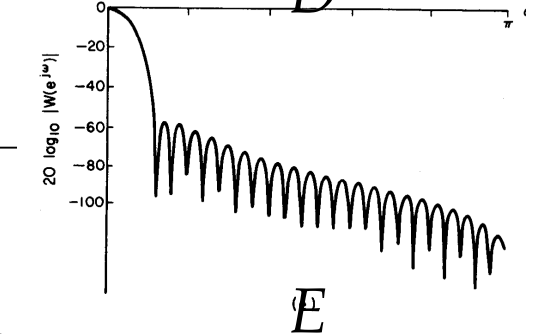
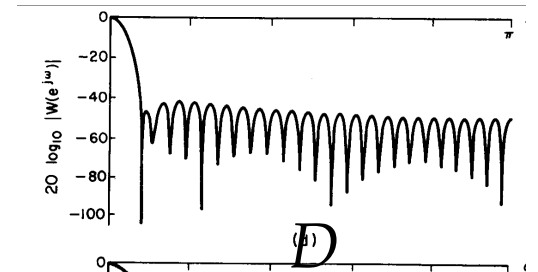



# Fermilab VSA

## Swept tuned analyzer

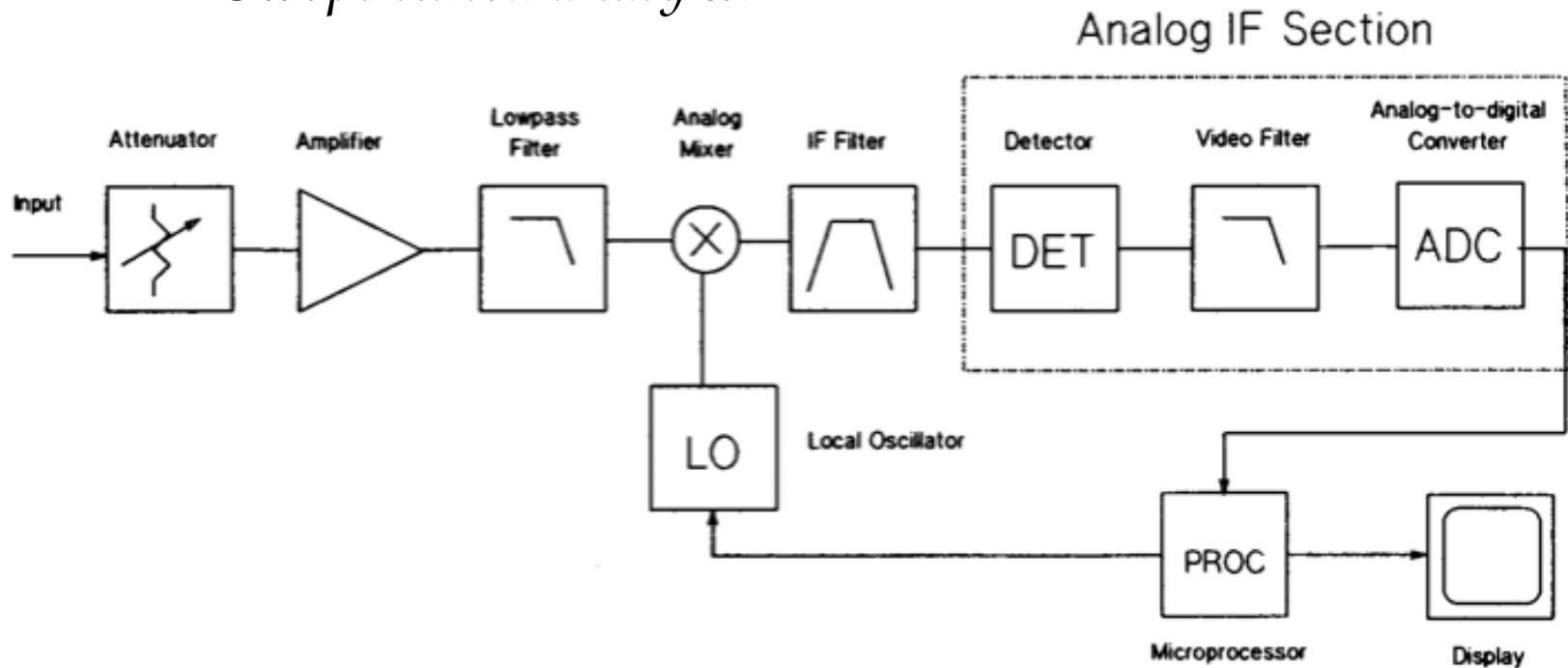



# Fermilab VSA

## VSA analyzer

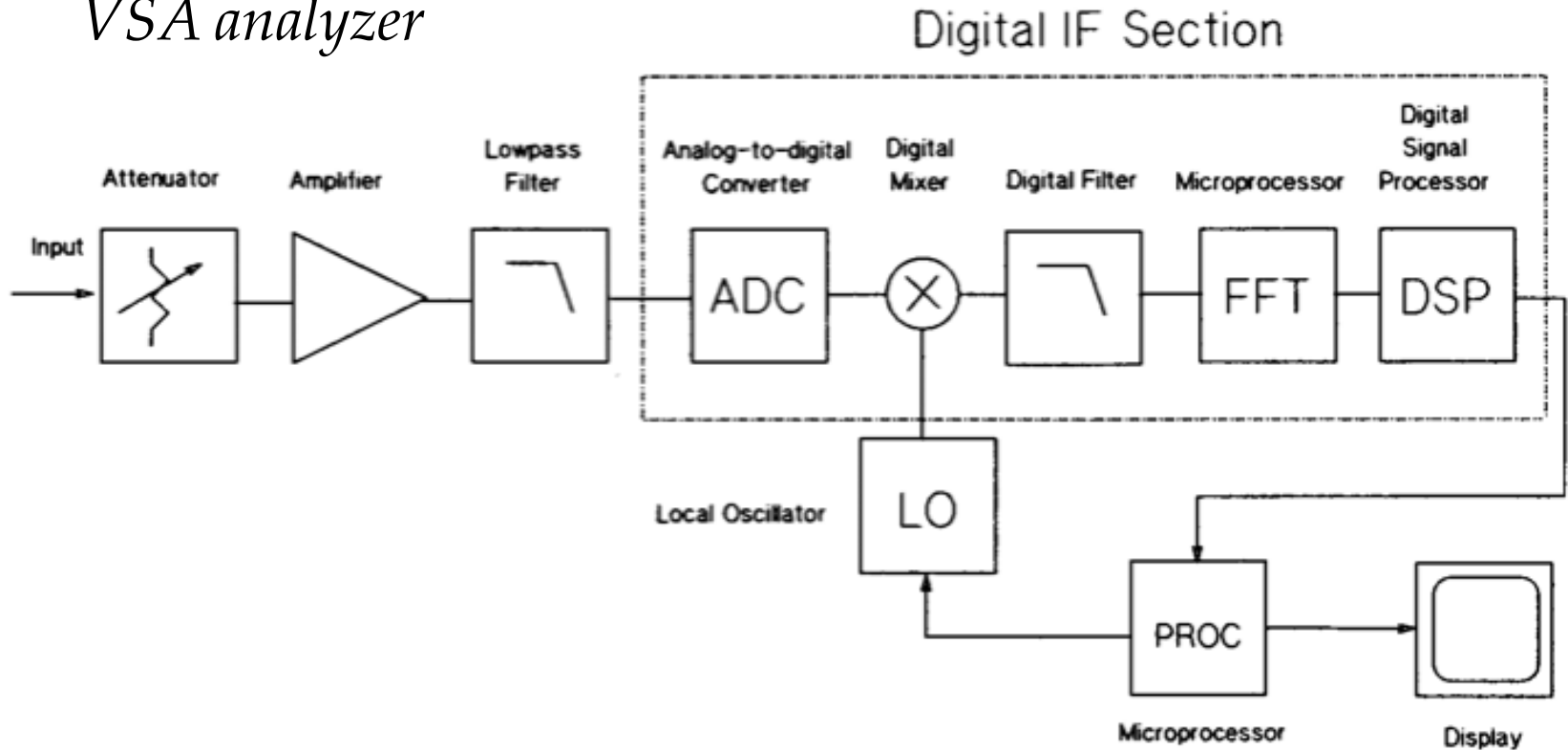



## ■ *Multiple Modes of Operation*

### ■ *Scalar Mode*

- | *Identify signals in wide span or small signals close to the noise floor, similar to swept tuned spectrum analyzer: measure oscillator harmonic distortion*

### ■ *Vector Mode*

- | *Analyze signals with phase and time data, fast transforms between time and frequency domain: measure oscillator side bands or phase noise*

### ■ *Demodulation Mode*

- | *Characterize amplitude, frequency and phase relationships: characterize oscillator sideband noise as AM or PM*



## ■ *Features*

- *Real time frequency analysis*
- *Fast measurements at narrow RB, up to 1000x faster than swept tuned spectrum analyzer*
- *Spectrogram allows for frequency spectrum vs time*
- *Water fall running plot of spectrums for transients*
- *Time capture buffer for post analysis*





# Fermilab VSA

## Tevatron 1.7 GHz Schottky Monitor

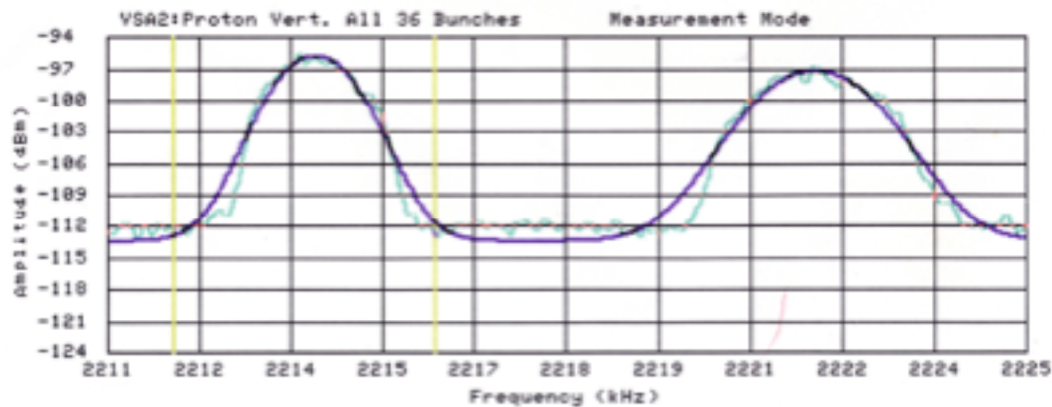
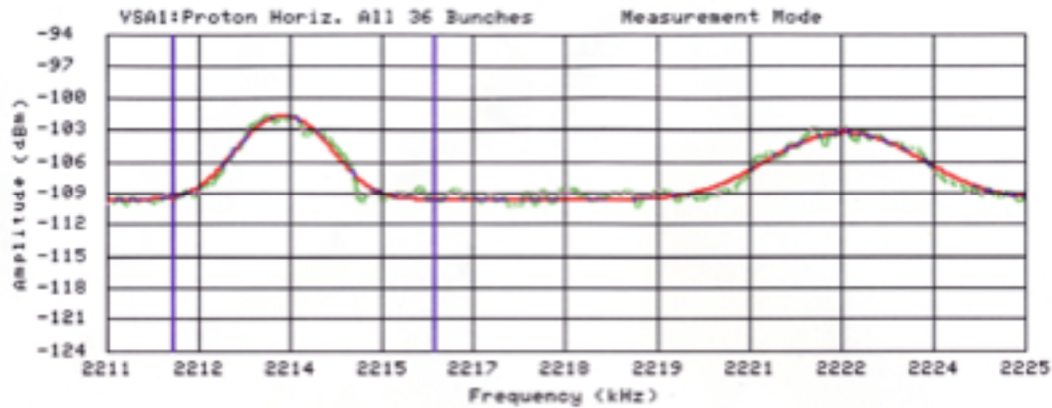



Fermilab VSA

## Tevatron 1.7 GHz Schottky Spectrogram

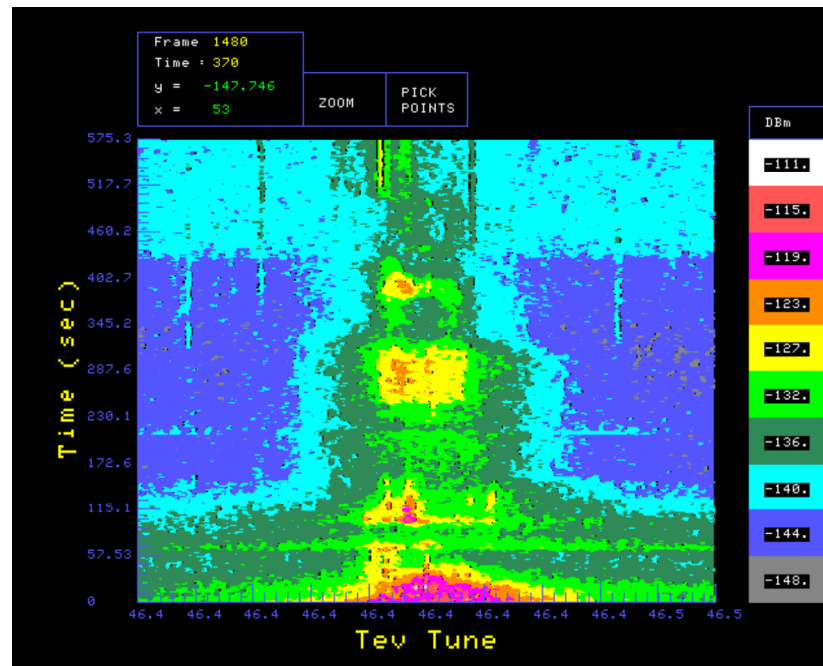



*Fermilab* VSA

## *References*

*Digital Signal Processing, Oppenheim & Schaffer,  
1975 Prentice Hall*

Agilent educators corner

[Fourier Theory & Practice, Part I: Theory \[Exp53a.pdf\]](#)

Fourier Theory & Practice, Part I: Theory (Agilent Product Note **54600-4**) By:  
Robert Witte Agilent Technologies Introduction: This product note provides a brief  
review of Fourier theory, especially the unique behavior of the FFT. The note also  
describes some typical applications and provides some . . .

<http://www.educatorscorner.com/media/Exp53a.pdf> 04/09/03, 280197 bytes